

SECTION A-A



SPPE / MANLIFT
ELEVATION VIEW

CAPACITY 500 lbs.

5MLRC1E14

REAR CWT

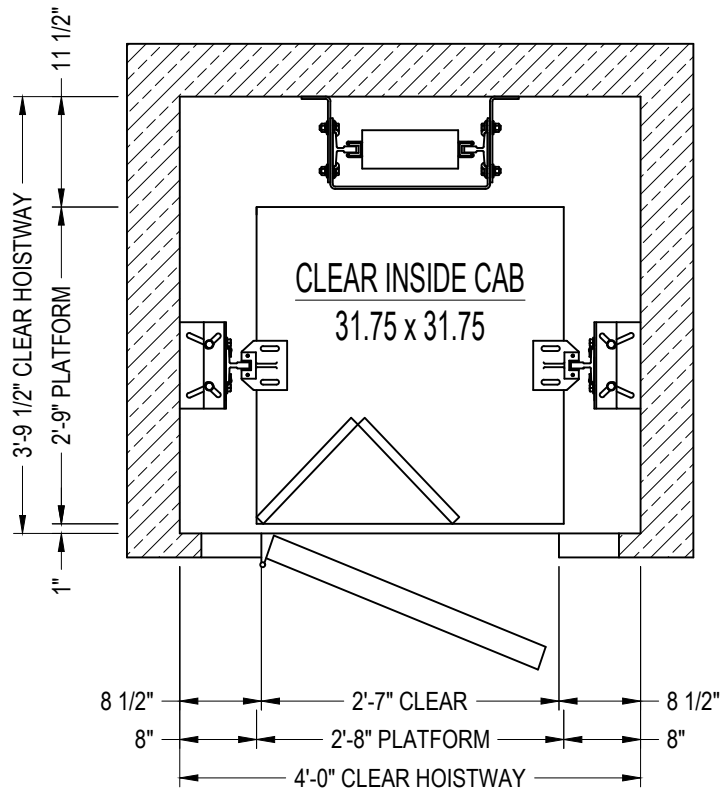

HOISTWAY PLAN



SPPE / MANLIFT

PLAN VIEW

CAPACITY 500 lbs.

5MLRC1E14

REAR CWT

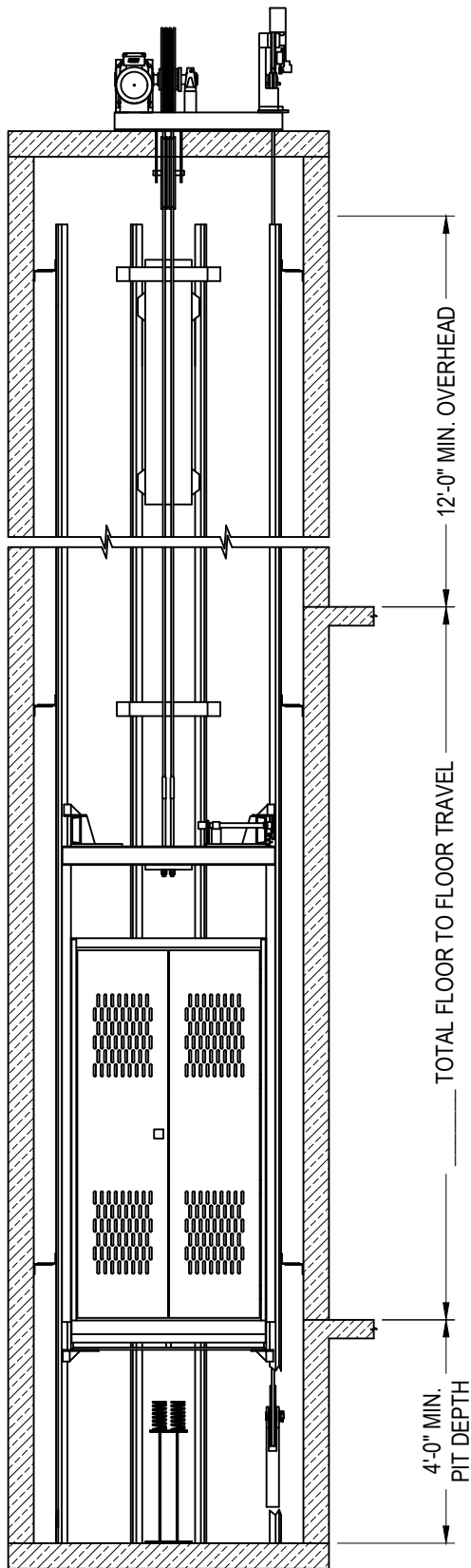

SECTION A-A

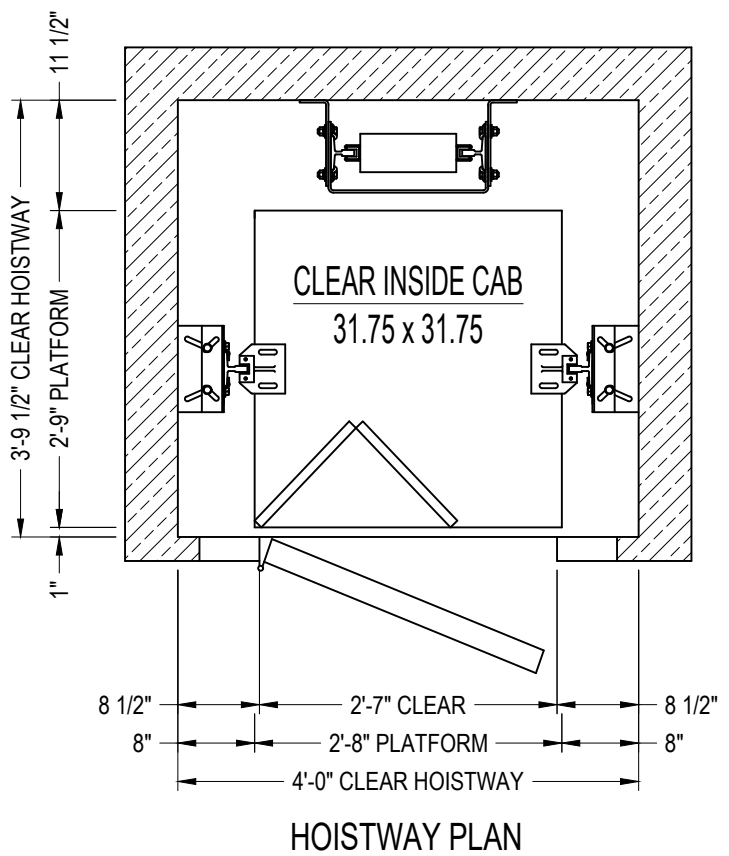

SPPE / MANLIFT
ELEVATION & PLAN VIEW

CAPACITY 500 lbs.

5MLRC1E14

REAR CWT