

SECTION A-A
NOT TO SCALE

*- DIMENSIONS VARY FOR DOOR SIZE, GATE TYPE, SPEED, ETC. DIMENSIONS GIVEN ARE BASED ON 7'-8" INSIDE CAB.



TRACTION FREIGHT
ELEVATION & PLAN VIEW

CAPACITY 5000 lbs.	50.TF.C.2E.14
VERTICAL BI-PARTING	

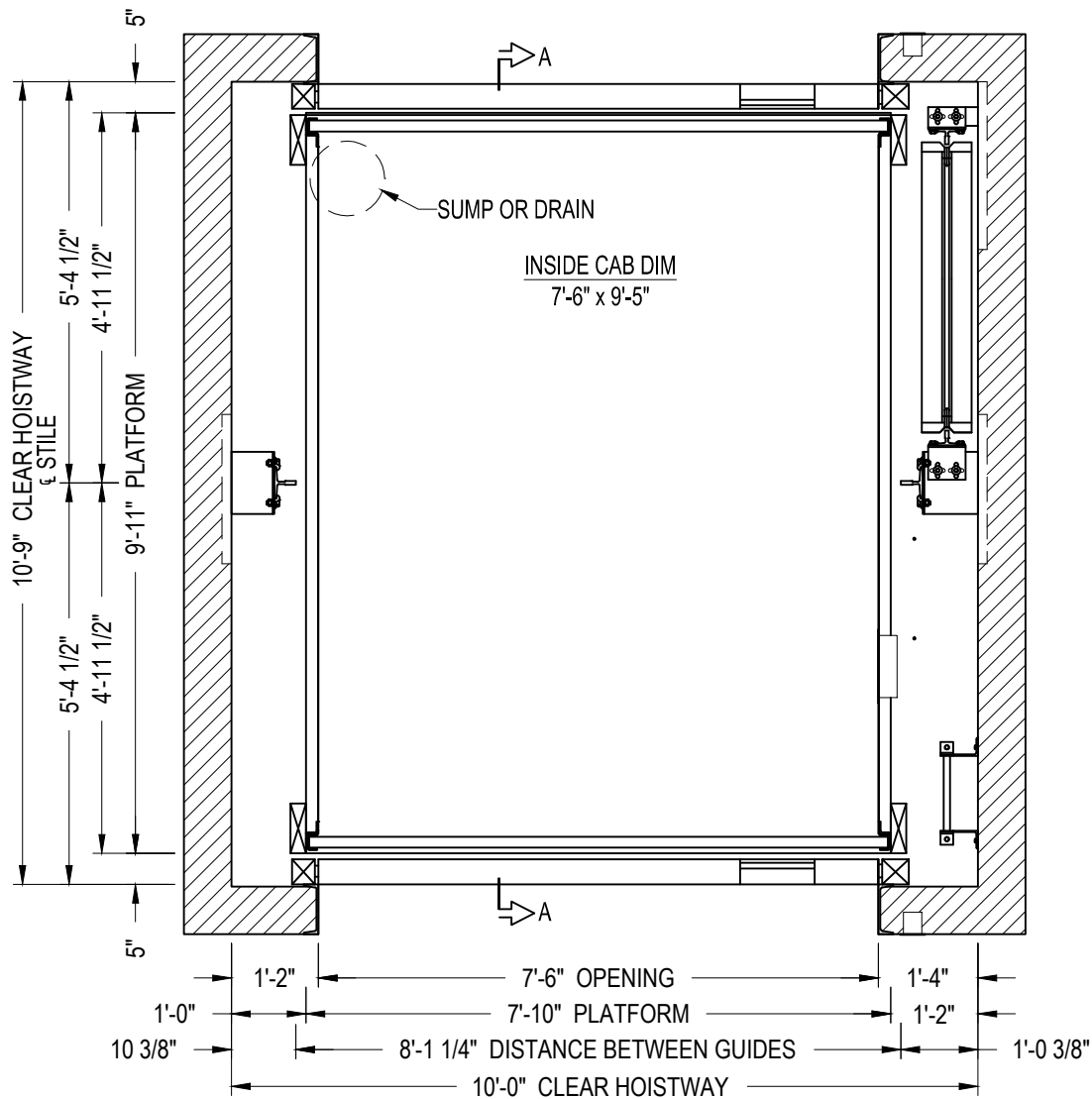

HOISTWAY PLAN



TRACTION FREIGHT
PLAN VIEW

CAPACITY 5000 lbs.	50.TF.C.2E.14
VERTICAL BI-PARTING	

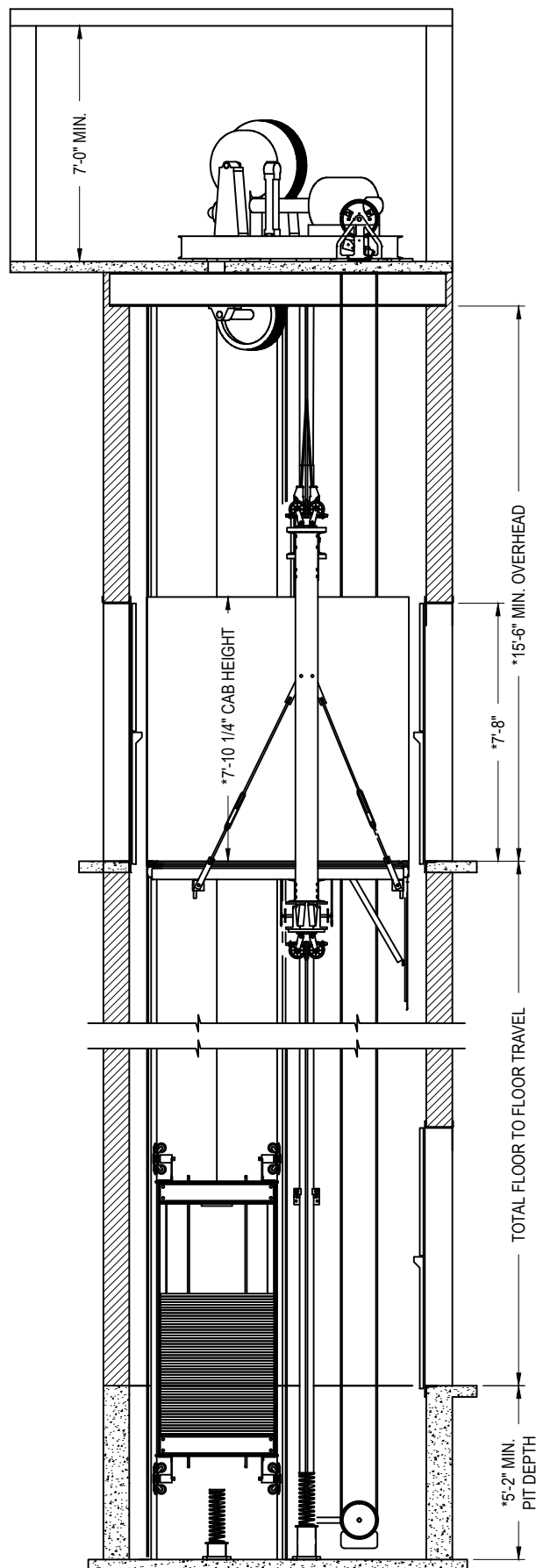

*- DIMENSIONS VARY FOR DOOR SIZE,
GATE TYPE, SPEED, ETC. DIMENSIONS
GIVEN ARE BASED ON 7'-8" INSIDE CAB.

SECTION A-A
NOT TO SCALE

TRACTION FREIGHT
ELEVATION VIEW

CAPACITY 5000 lbs.

50.TF.C.2E.14

VERTICAL BI-PARTING

