

SECTION A-A
NOT TO SCALE

* CONSULT LITERATURE FOR SPEEDS EXCEEDING 200 fpm

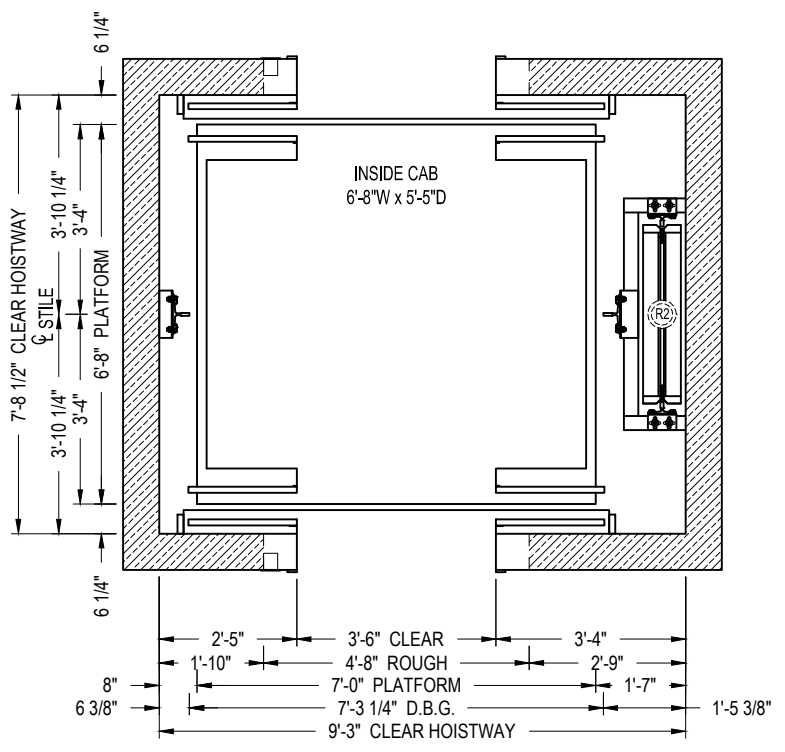

CENTER PARTING HOISTWAY PLAN

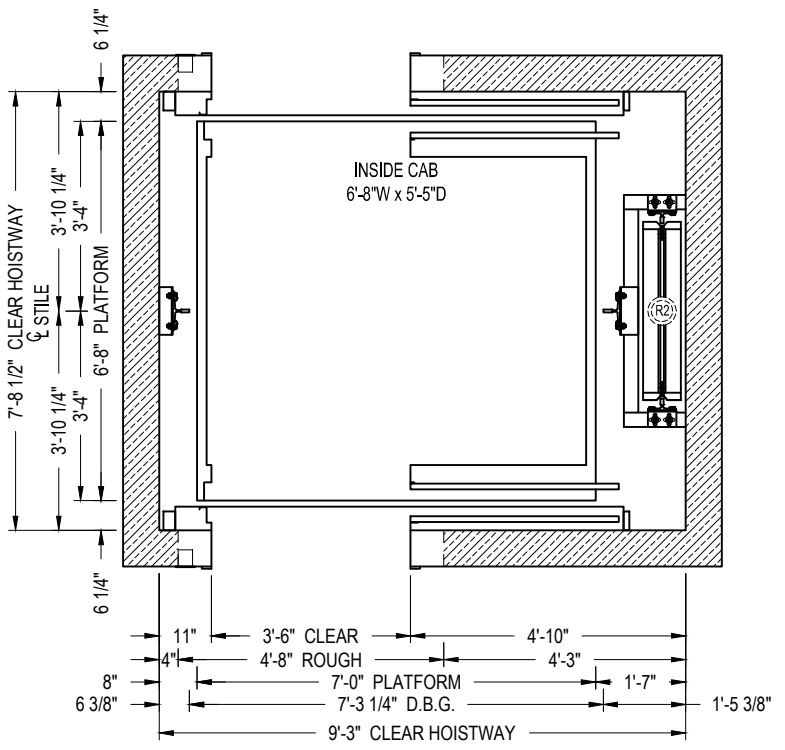

SINGLE SPEED HOISTWAY PLAN



GEARED TRACTION
ELEVATION & PLAN VIEW

CAPACITY 3500 lbs.

35GTSS2E14

SINGLE SLIDE & CENTER PARTING

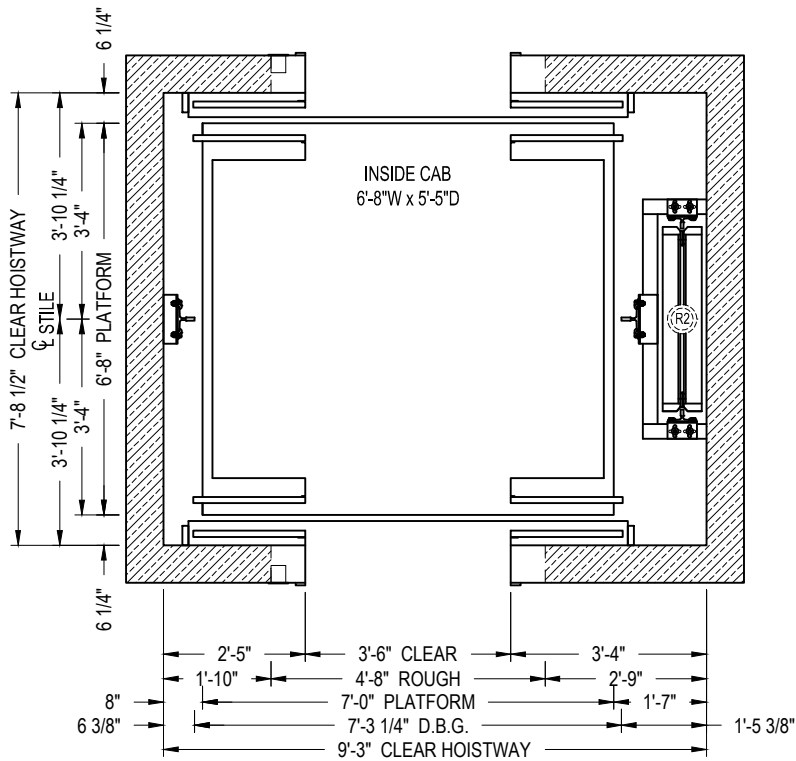

CENTER PARTING HOISTWAY PLAN

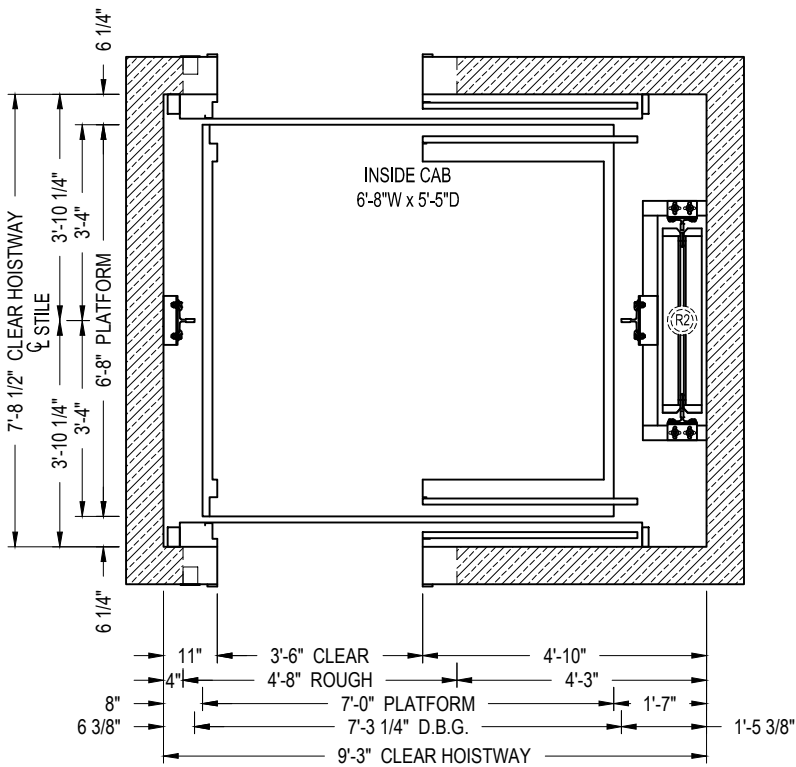

SINGLE SPEED HOISTWAY PLAN



GEARED TRACTION
 PLAN VIEW

CAPACITY 3500 lbs.

35GTSS2E14

SINGLE SLIDE & CENTER PARTING

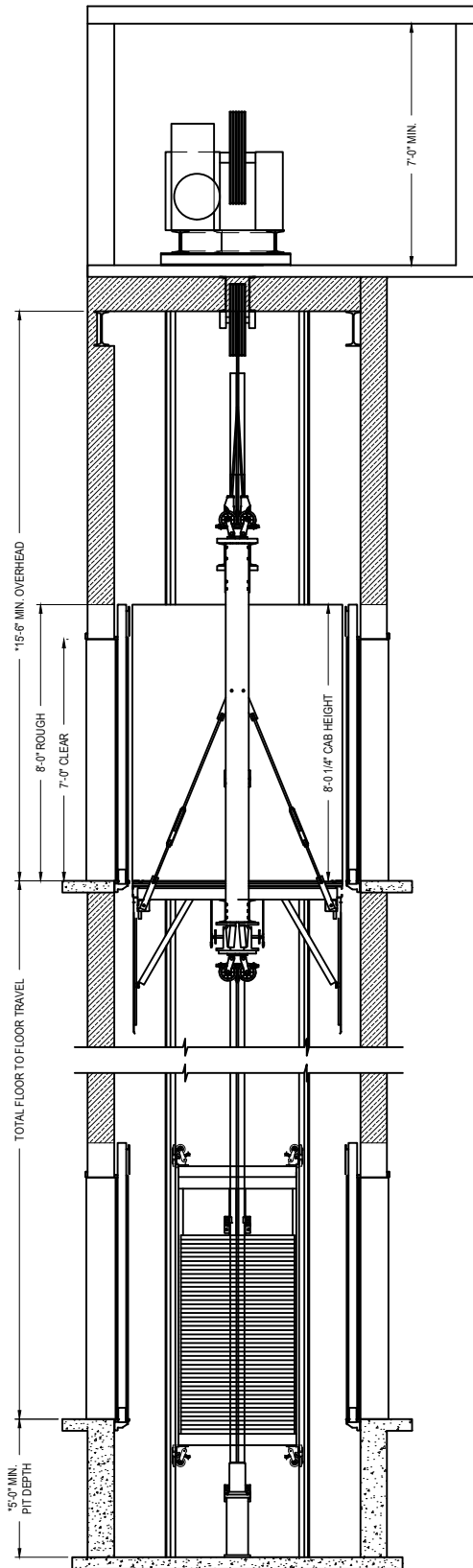

SECTION A-A
NOT TO SCALE

* CONSULT LITERATURE FOR
SPEEDS EXCEEDING 200 fpm



GEARED TRACTION
ELEVATION VIEW

CAPACITY 3500 lbs.

35GTSS2E14

SINGLE SLIDE & CENTER PARTING