

SECTION A-A
NOT TO SCALE

* CONSULT LITERATURE FOR SPEEDS EXCEEDING 200 fpm

CENTER PARTING HOISTWAY PLAN

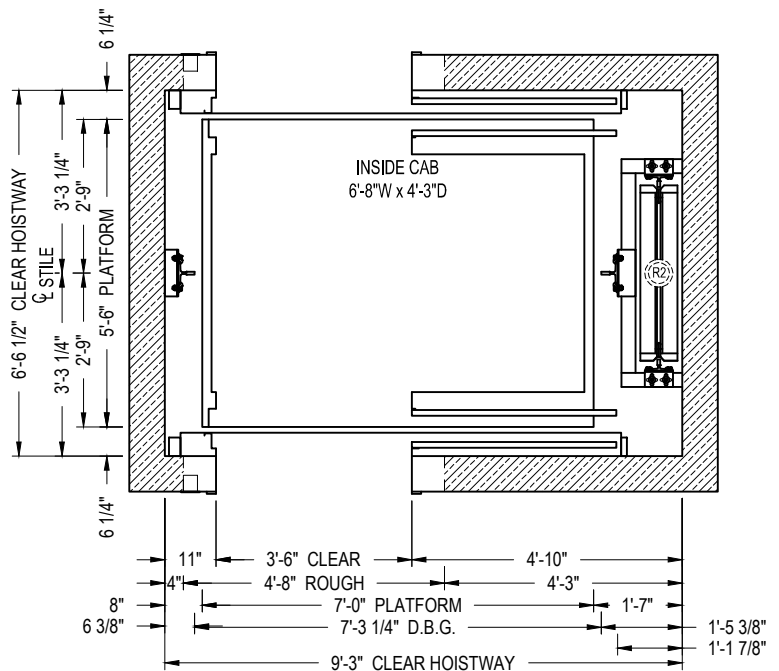

SINGLE SPEED HOISTWAY PLAN



**GEARLESS TRACTION
ELEVATION & PLAN VIEW**

CAPACITY 2500 lbs.

25GLTSS2E14

SINGLE SLIDE & CENTER PARTING

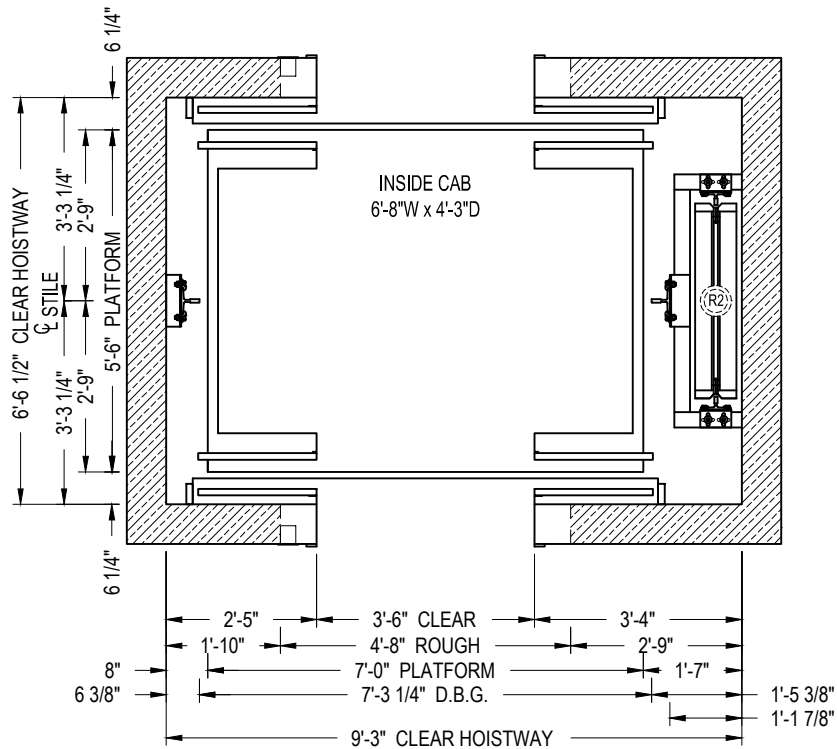

CENTER PARTING HOISTWAY PLAN

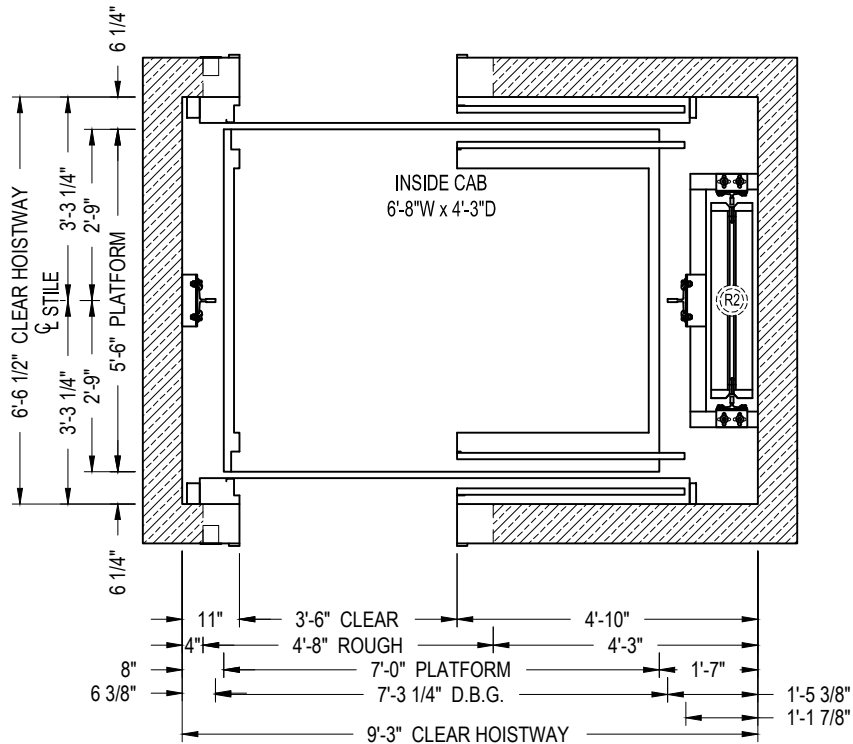

SINGLE SPEED HOISTWAY PLAN



GEARLESS TRACTION

PLAN VIEW

CAPACITY 2500 lbs.

25GLTSS2E14

SINGLE SLIDE & CENTER PARTING

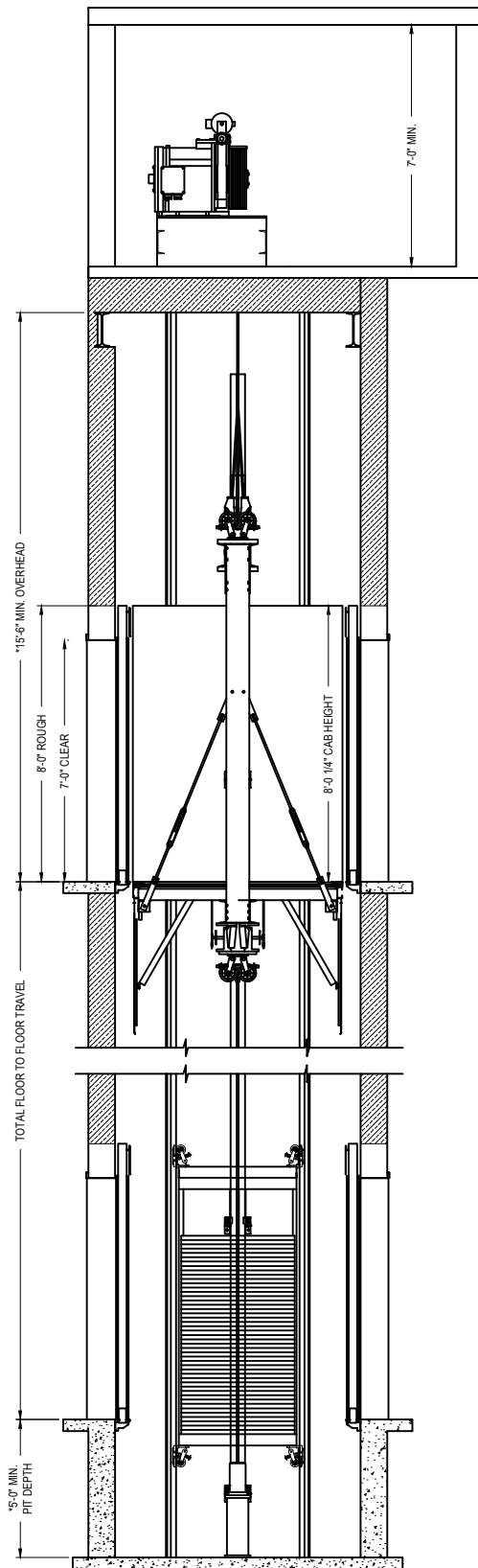

SECTION A-A
NOT TO SCALE

*- CONSULT LITERATURE FOR SPEEDS EXCEEDING 200 fpm



GEARLESS TRACTION
ELEVATION VIEW

CAPACITY 2500 lbs.

25GLTSS2E14

SINGLE SLIDE & CENTER PARTING