

SECTION A-A
NOT TO SCALE

*- DIMENSIONS VARY FOR DOOR SIZE, GATE TYPE, SPEED, ETC. DIMENSIONS GIVEN ARE BASED ON 7'-8" INSIDE CAB.



TRACTION FREIGHT
ELEVATION & PLAN VIEW

CAPACITY 8000 lbs.

80.TF.C.2E.14

VERTICAL BI-PARTING

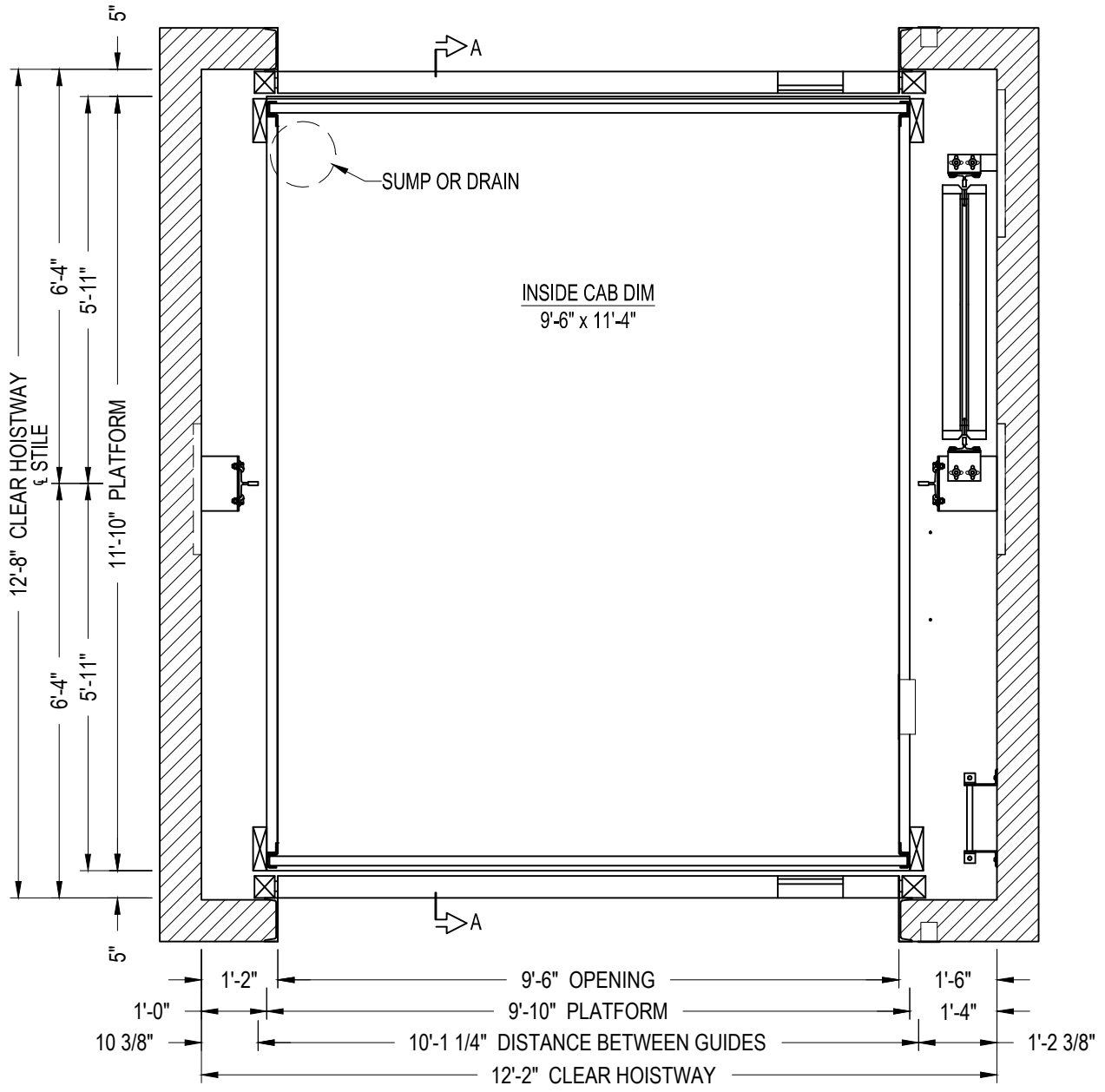

HOISTWAY PLAN



TRACTION FREIGHT
 PLAN VIEW

CAPACITY 8000 lbs.	80.TF.C.2E.14
VERTICAL BI-PARTING	

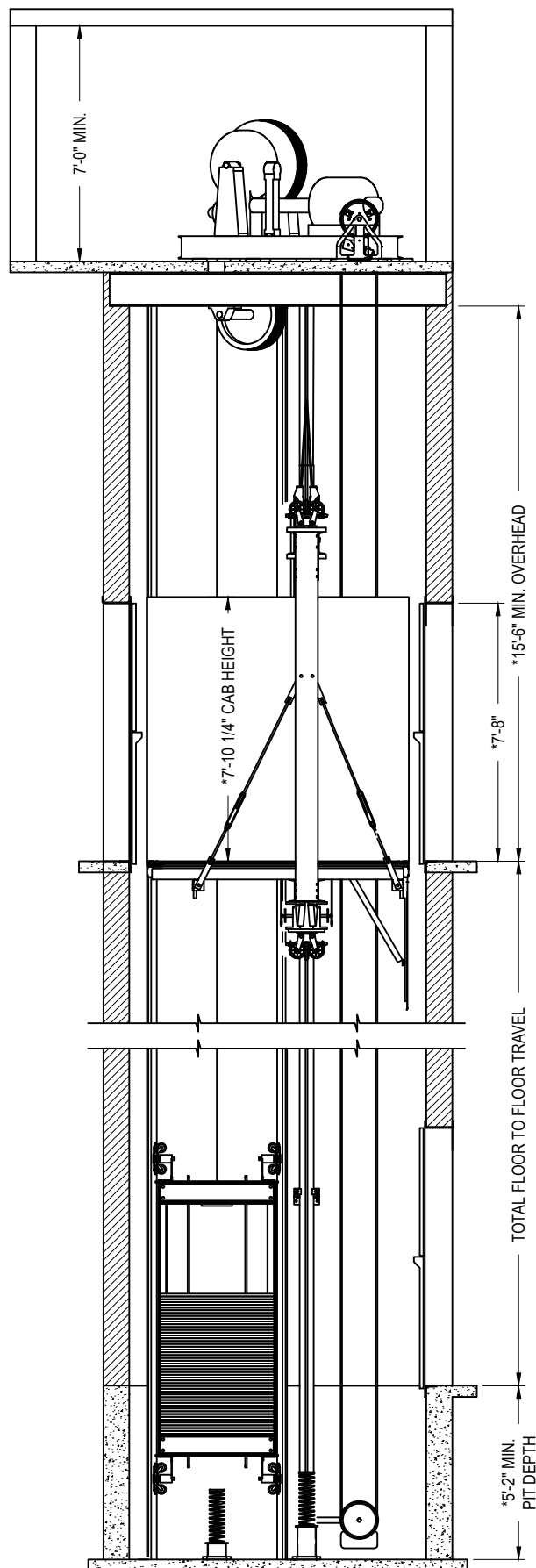

*- DIMENSIONS VARY FOR DOOR SIZE,
GATE TYPE, SPEED, ETC. DIMENSIONS
GIVEN ARE BASED ON 7'-8" INSIDE CAB.

SECTION A-A
NOT TO SCALE

TRACTION FREIGHT
ELEVATION VIEW

CAPACITY 8000 lbs.

80.TF.C.2E.14

VERTICAL BI-PARTING

